

### FEATURED MODEL

441753 Semi Professional 1.5 gpm, CHROME

### ADDITIONAL MODELS

440557 Semi Professional 2.2 gpm, SATIN NICKEL

440558 Semi Professional 2.2 gpm, CHROME

441408 Semi Professional 1.8 gpm, CHROME

441409 Semi Professional 1.8 gpm, SATIN NICKEL

441754 Semi Professional 1.5 gpm, SATIN NICKEL

### FEATURES

- Solid brass body and pull-down handspray
- Ceramic disk cartridge
- Extra long supply lines
- 1.5 GPM flow rate
- Installation in a 1-3/8" hole
- Color coded hot and cold supply lines
- 5" to 6" pull down
- 360 degree spout swivel
- 3" backsplash clearance off center
- 3-1/2" maximum deck thickness

### OPTIONAL ACCESSORIES

Meridian Soap Dispenser: 440059 (Chrome)

### CODE/STANDARDS COMPLIANCE

ASME A112.18.1-2011

NSF 61 certified

NSF 61 ANEX G low lead requirements

CEC Listed - CA

CMR 248 - MA

**AB1953 Lead Free**

### WARRANTY

BLANCO'S kitchen and bar faucets feature a LIMITED LIFETIME WARRANTY to be free of all manufacturing defects under normal use. See our complete warranty for details.

While BLANCO endeavors to provide accurate information, all dimensions are nominal, cannot be guaranteed, and are subject to change or cancellation. BLANCO assumes no responsibility for use of superseded or voided specifications.

### JOB INFORMATION

Job Name: \_\_\_\_\_

Contact: \_\_\_\_\_

Date Specified: \_\_\_\_\_

Specifier: \_\_\_\_\_

Contractor: \_\_\_\_\_



### NOMINAL DIMENSIONS

Model 441753 shown

REACH	SPOUT HEIGHT	FAUCET HEIGHT
8-3/8"	5-3/4"	19-1/4"

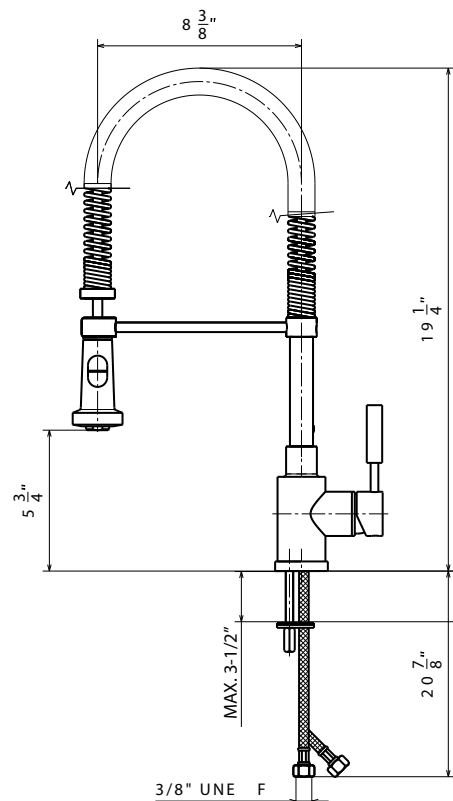

See next page for exploded parts drawing and parts list.

**BLANCO AMERICA**

888.668.6201

www.blancoamerica.com

© 2014 BLANCO AMERICA

9/14

SPEC-001

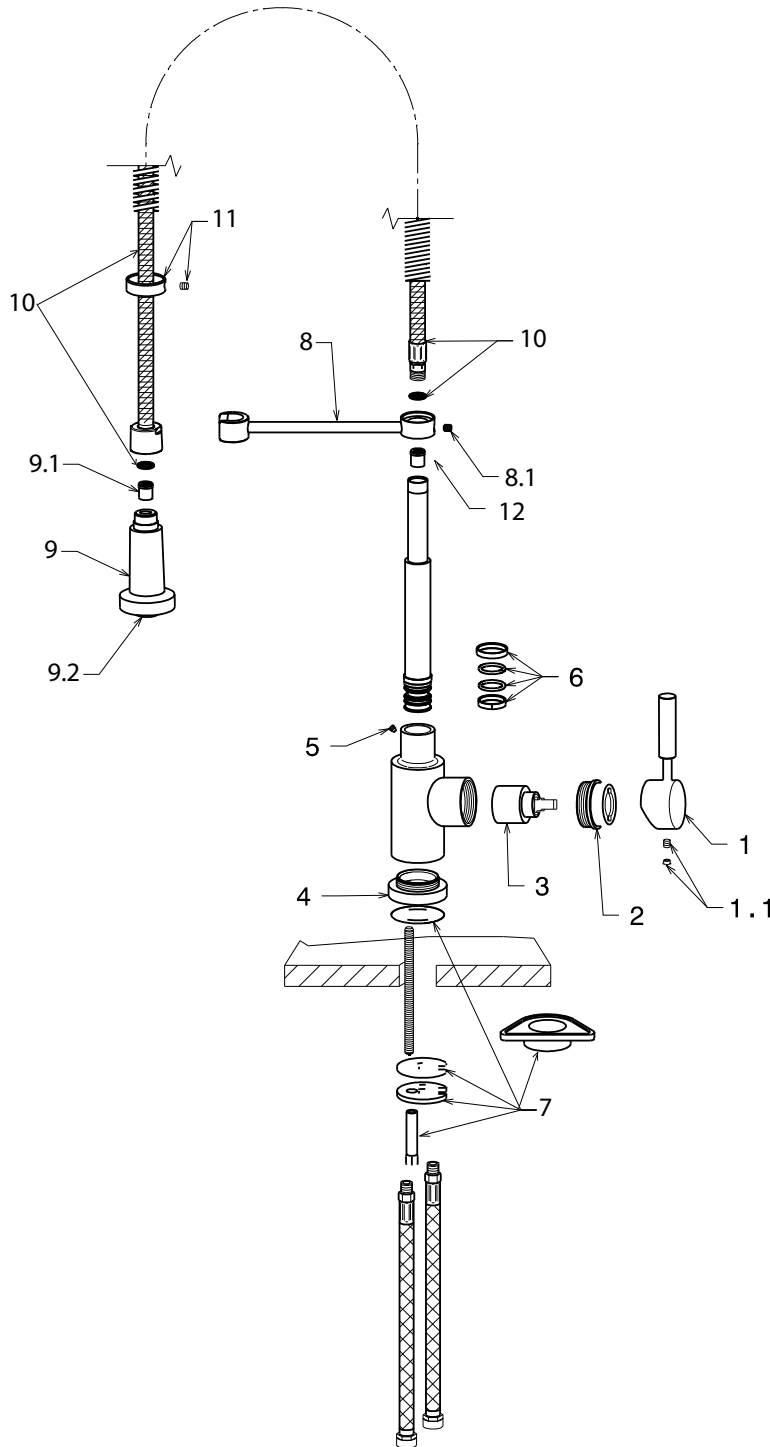

## REPAIR PART GUIDE

Num.	Description	Part #
1, 1.1	Handle - Chrome	441859
1.1	Handle - Screw and Cap	440889
2	Cartridge Lock Nut	441861
3	Cartridge	440877
4	Round base - Chrome	441863
5	Holding screw	441745
6	O-ring set	441744
7	Mounting set	441751
8, 8.1	Handspray dock station and screw	441865
8.1	Docking station screw	441867
9,9.1,9.2	Handspray - Chrome	441935
9.1	Flow regulator 1.5	441951
9.2	Aerator	441766
10	Pull-out hose	441737
11	Spring ring & screw - Chrome	441868
12	Flow regulator/check valve	441743

## Need to Change a Faucet Cartridge?



Scan this QR code  
to see our how-to video

For faucet technical support or questions,  
please e-mail us at [blanco@blancoamerica.com](mailto:blanco@blancoamerica.com)