

FEATURED MODEL

440224 Equal Double, 10" bowl depths

ADDITIONAL MODELS

440207 Equal Double, 8" bowl depths

FEATURES

- Required outside cabinet: 36"
- 18 gauge, 304 series stainless steel
- Premium 18/10 chrome/nickel content
- Satin Polish finish
- Rear drain placement provides MAXIMUM flat space
- Sound deadening pads

OPTIONAL ACCESSORIES

Stainless Steel Sink Grids: 220993

Colanders: 510889

CODE/STANDARDS COMPLIANCE

ASME 112.19.3-00

IAPMO/UPC listed



NOMINAL DIMENSIONS

Model 440224 shown

OVERALL	CUT OUT SIZE	BOWL DEPTHS		DRAIN
		LEFT	RIGHT	
32" x 20-7/8"	Template provided with approximate 1/8" reveal	10"	10"	3-1/2"

DXF cutout templates available on our website.

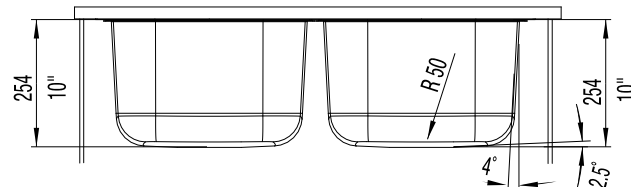
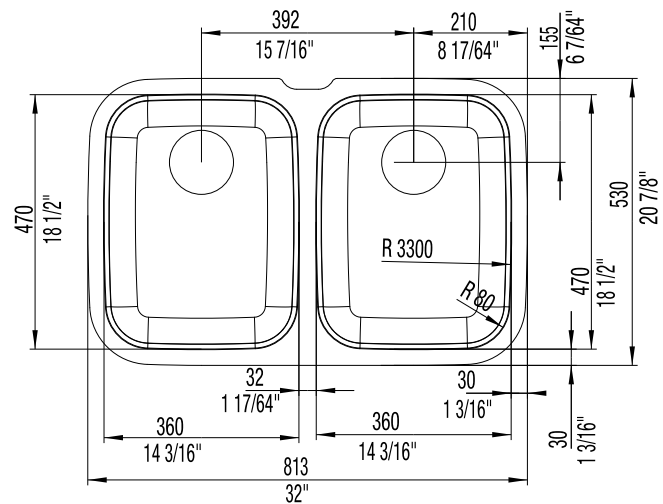

WARRANTY

Blanco America's Stainless Steel sinks feature a LIMITED LIFETIME WARRANTY to be free of all manufacturing defects under normal use. See our complete warranty for details.

While Blanco America endeavors to provide accurate information, all dimensions are nominal, cannot be guaranteed, and are subject to change or cancellation. Blanco America assumes no responsibility for use of superseded or voided specifications.

JOB INFORMATION

Job Name: _____

Contact: _____

Date Specified: _____

Specifier: _____

Contractor: _____

BLANCO AMERICA

800.451.5782

www.blancoamerica.com

© 2013 BLANCO AMERICA

6/13

SPEC-003