

Product information sheet ANDANO 500-IF

Item no. 526897

Benefits



- Balanced composition of optical and functional elements
- The harmonious interplay between the radii and surface design creates a modern appeal
- High quality features consisting of a covered C-overflow and InFino drain system – gracefully integrated and easy-care
- Large bowl capacity and fully utilisable base
- Elegant IF flat-rim for flushmount and for installation from above
- Optional premium accessories are available

Scope of supply

- waste kit
- 3 ½" InFino basket strainer
- fixing kit

Details

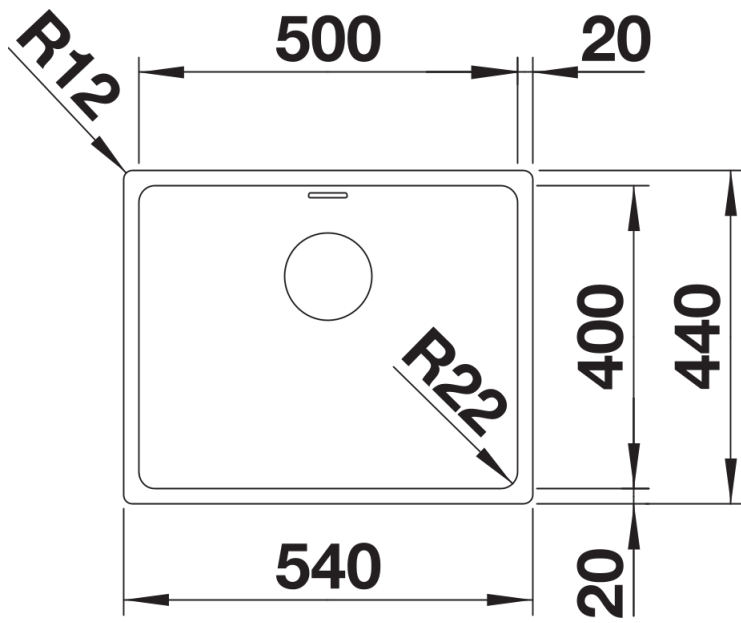

Top view

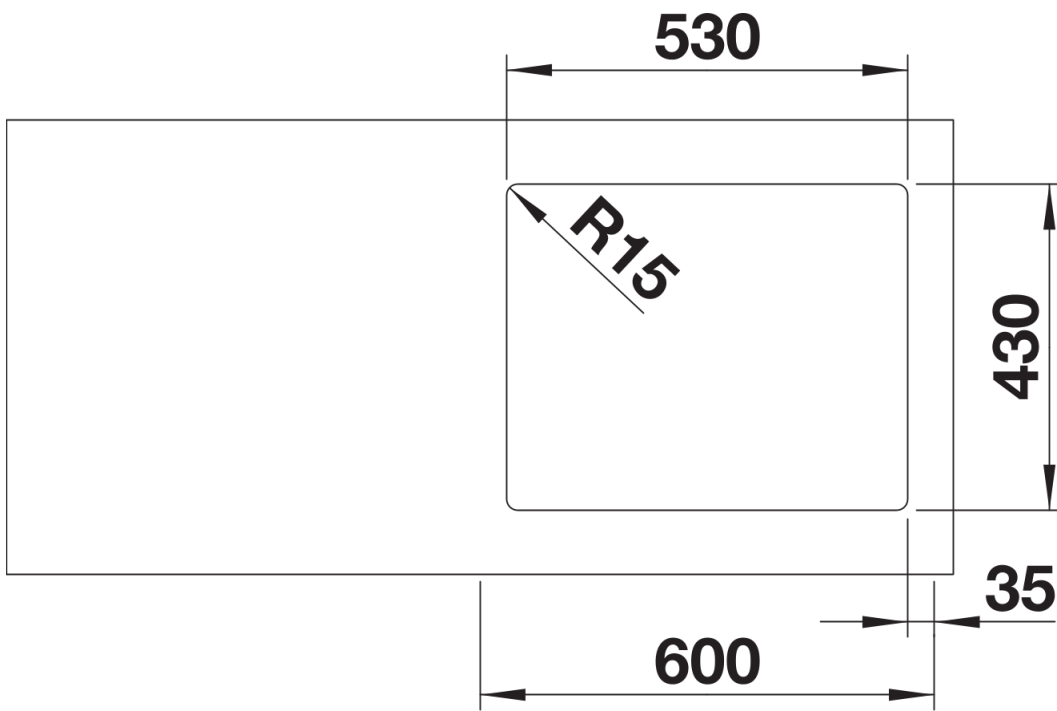

Cut-out

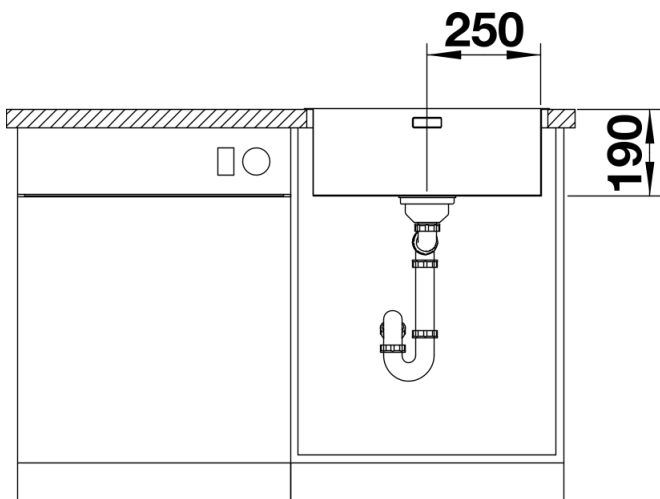

Front view

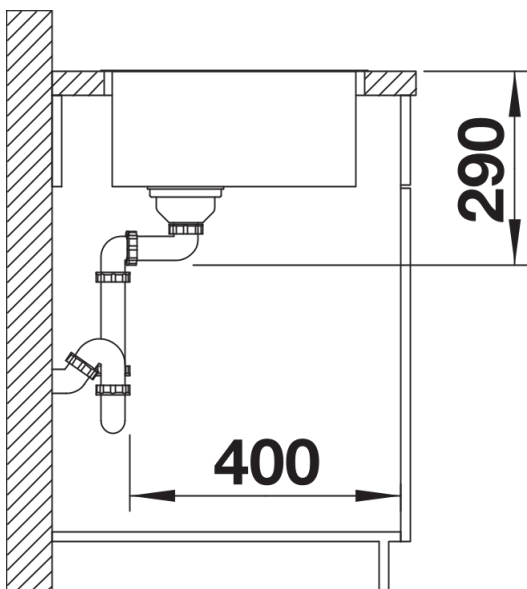

Side view