

Product information sheet SOLIS 500-U

Item no. 526122

Benefits



- A harmonious interplay between functional and visual elements
- High-quality features with covered C-overflow and InFino drain system – elegantly integrated and easy-care
- Convenient bowl volume and base surface designed for practical use
- Functional accessories optionally available

Planning information

- Cut out information supplied with bowls.
- Cut out CNC files also available on www.blanco.co.uk for download.

Scope of supply

- Waste kit with space-saving pipe
- 3 ½" InFino basket strainer
- fixing kit

Details

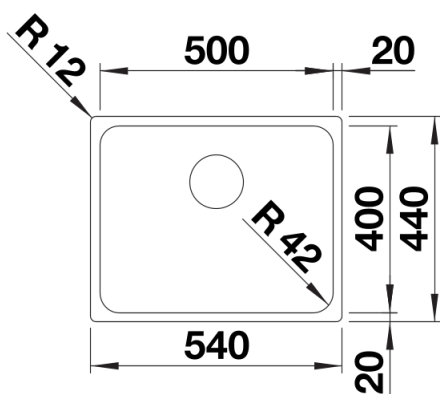

Top view

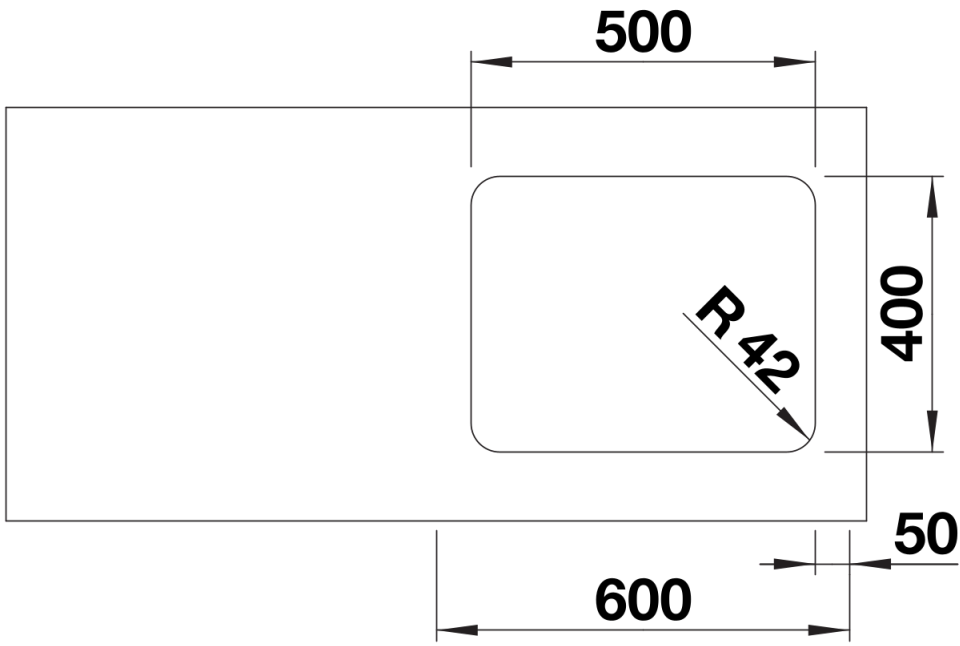

Cut-out

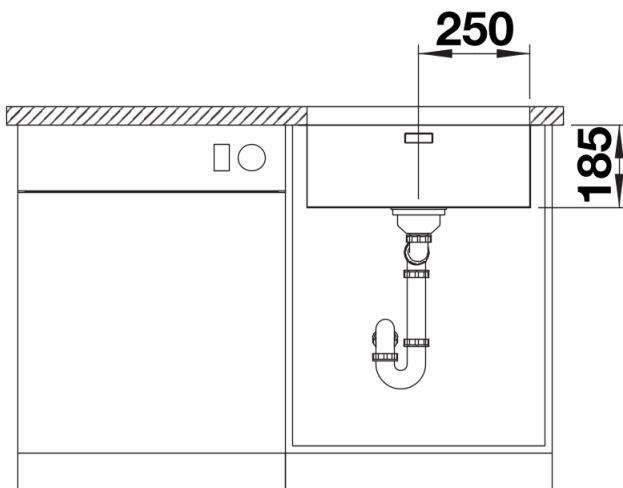

Front view

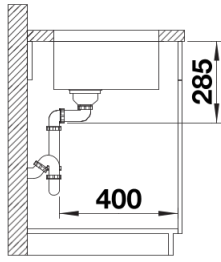

Side view