

Product information sheet SUBLINE 320-U

Item no. 527160

Benefits



- Our versatile SUBLINE kitchen sink range fits harmoniously into the worktop: great for minimalist kitchens
- Straight-lined design: timelessly elegant
- Works as a prep sink combined with a larger sink for washing up or as a utility room sink
- Elegant InFino strainer for swift water drainage

Colours



Available colours:

black
anthracite
rock grey
volcano grey
white
soft white
tartufo
coffee

SILGRANIT soft white

Planning information

- Cut out: 320 x 400 x R10
Note: Please order waste connections for combinations of two individual bowls separately.

Scope of supply

- Waste fitting with space-saving pipe
- 3 ½" InFino basket strainer

Details

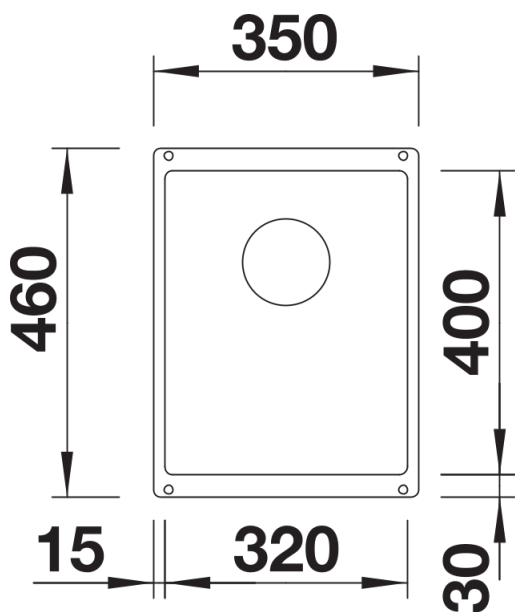

Top view

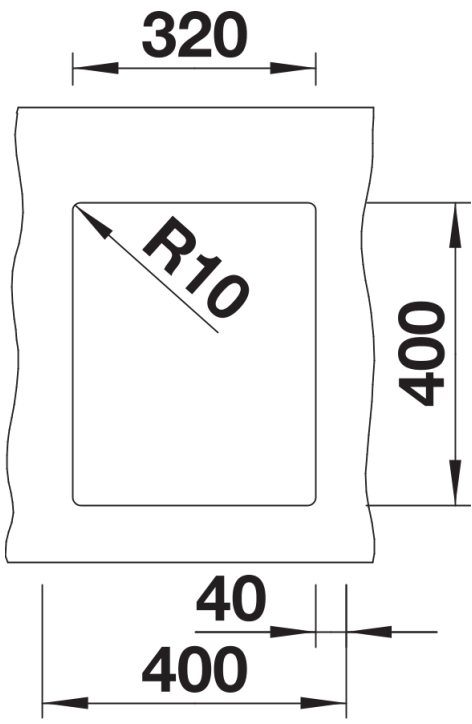

Cut-out

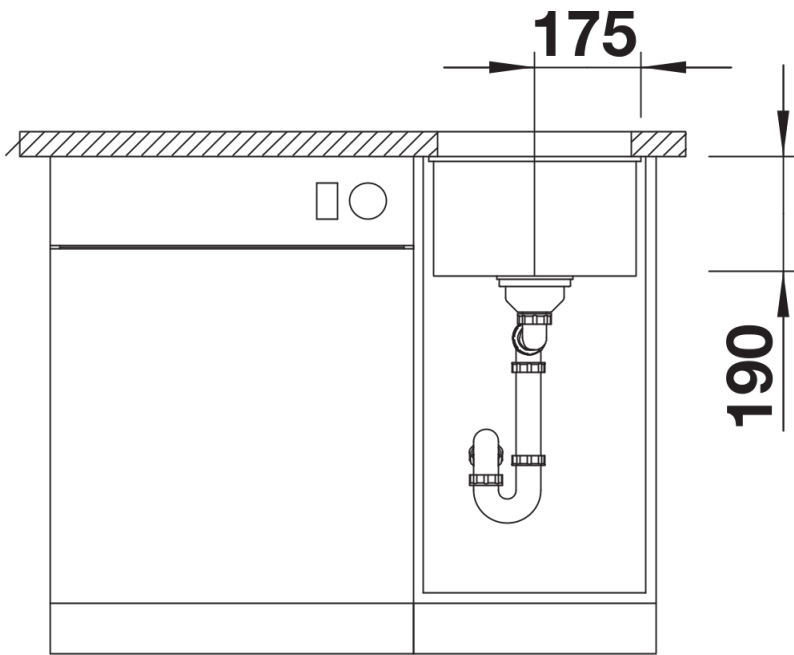

Front view

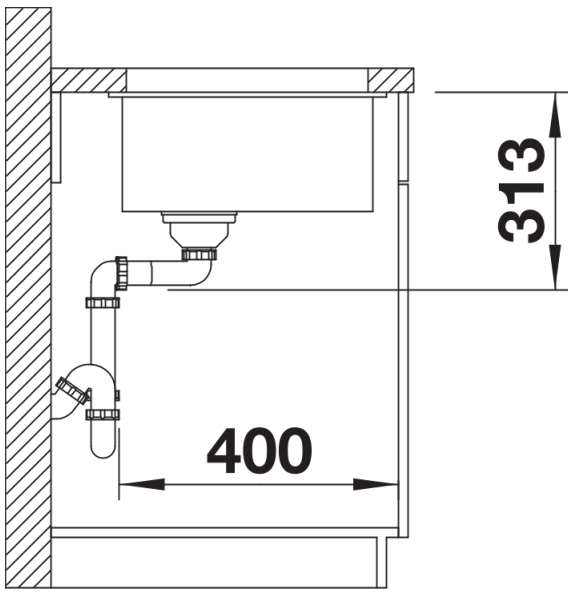

Side view