

Product information sheet ETAGON 700-IF

Item no. 524272

Benefits



- Generous staggered bowl with added functionality
- Integrated step creates an additional functional level
- Clever system concept with versatile ETAGON rails
- High-quality features with the covered C-overflow and InFino drain system – elegantly integrated and easy-care

Planning information

- Note: Installing a kitchen mixer tap, drain remote control or soap dispenser in laminate worktops requires a flexible sealing tape.

Scope of supply

- 2 x ETAGON rails in stainless steel
- waste kit with space-saving pipe
- 3 ½" InFino basket strainer
- fixing kit

234164 - 2 x ETAGON rails

Details

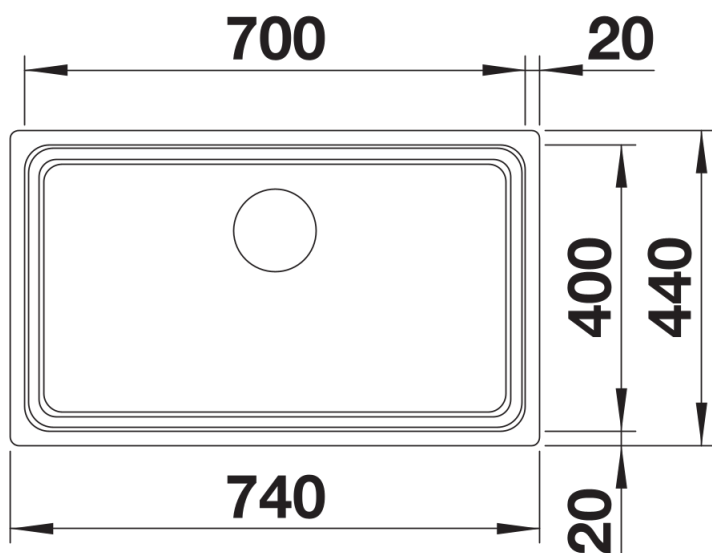

Top view

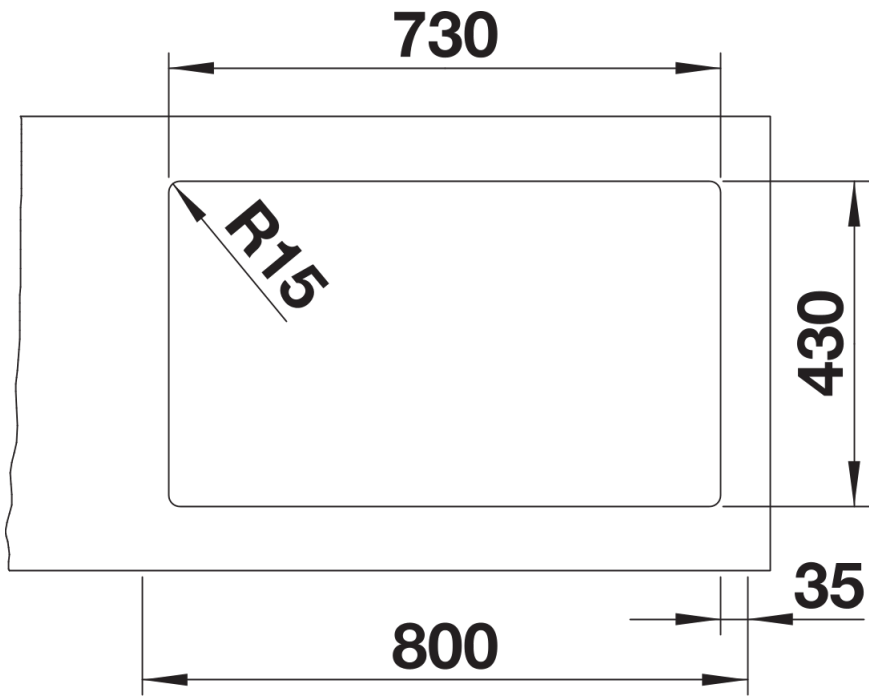

Cut-out

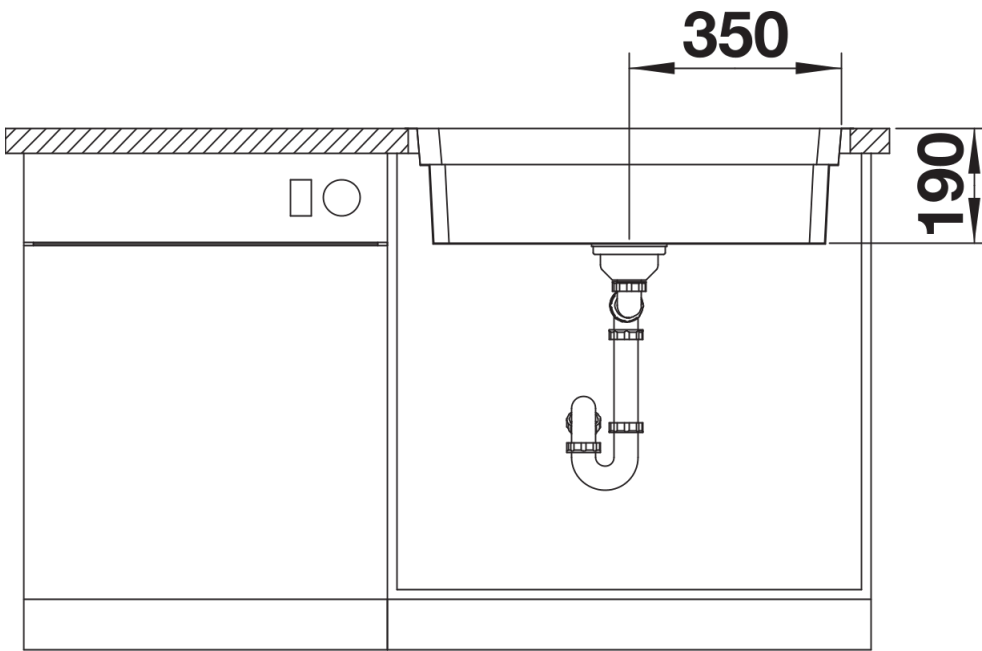

Front view

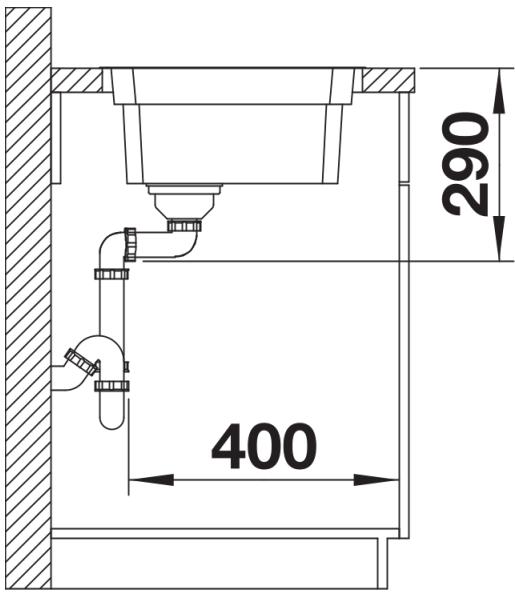

Side view