

## Product information sheet ANDANO 500-IF/A

Item no. 525245

### Benefits

---



- Unique composition of optical and functional elements
- The harmonious interplay between the radii and surface design creates a modern appeal
- Elegantly designed wet area with an integrated tap ledge in just one worktop cutout
- High quality features consisting of a covered Coverflow and InFino drain system with PushControl the slim and intuitive remote control
- Large bowl capacity and fully utilisable base
- Optional premium accessories are available

## Planning information

---

- Additional drill hole possible for the individual 400IFA 500IFA and 700IFA bowls The subsequent drill hole should be carried out by a specialist company
- With the double bowls 340180IFA 340340IFA and 400400IFA additional drle hole is not possible

## Scope of supply

---

- waste kit with spacesaving pipe
- 3 12 InFino basket strainer with drain remote control PushControl
- fixing kit

## Details

---

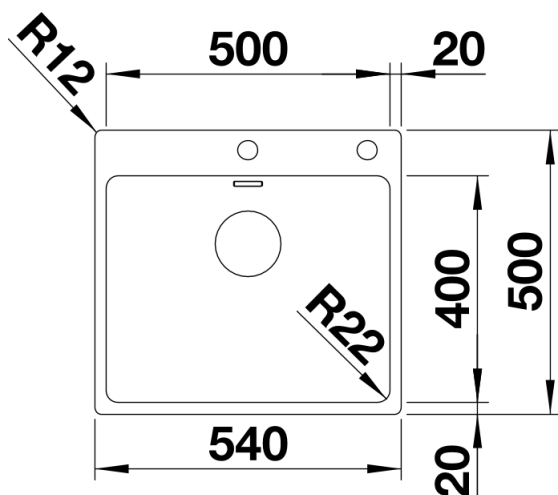

Top view

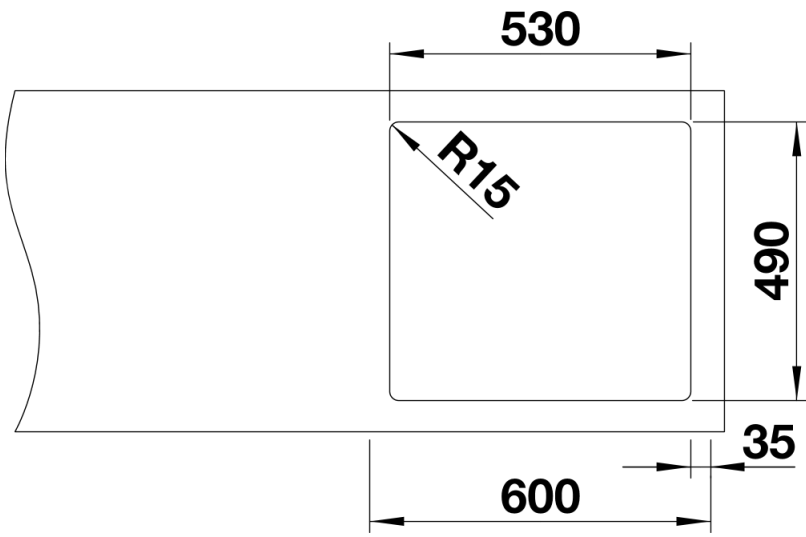

Cut-out

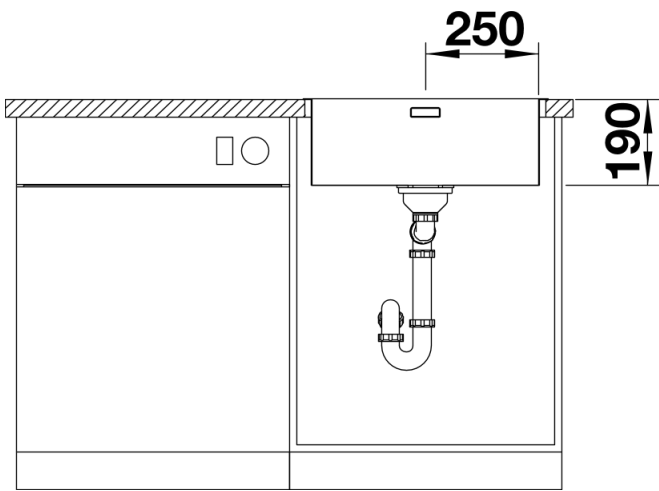

Front view

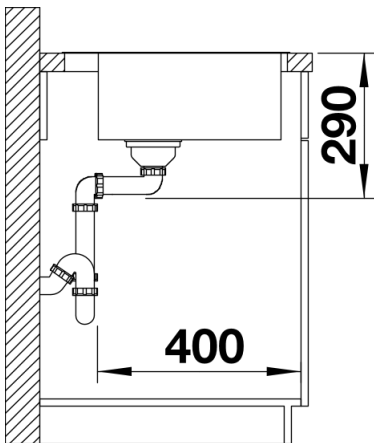

Side view