

Product information sheet SOLIS 450-U

Item no. 526120

Benefits



- A harmonious interplay between functional and visual elements
- High-quality features with covered C-overflow and InFino drain system – elegantly integrated and easy-care
- Convenient bowl volume and base surface designed for practical use
- Functional accessories optionally available

Planning information

- Note: Please order drain connections for combinations of two individual bowls separately.

Scope of supply

- waste kit with space-saving pipe
- 3 ½" InFino basket strainer
- fixing kit

Details

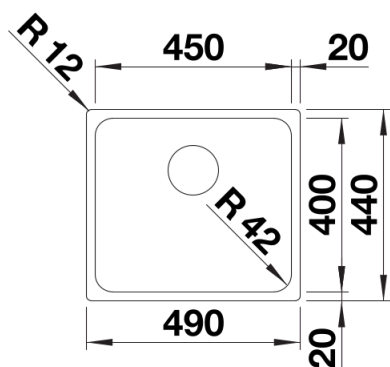

Top view

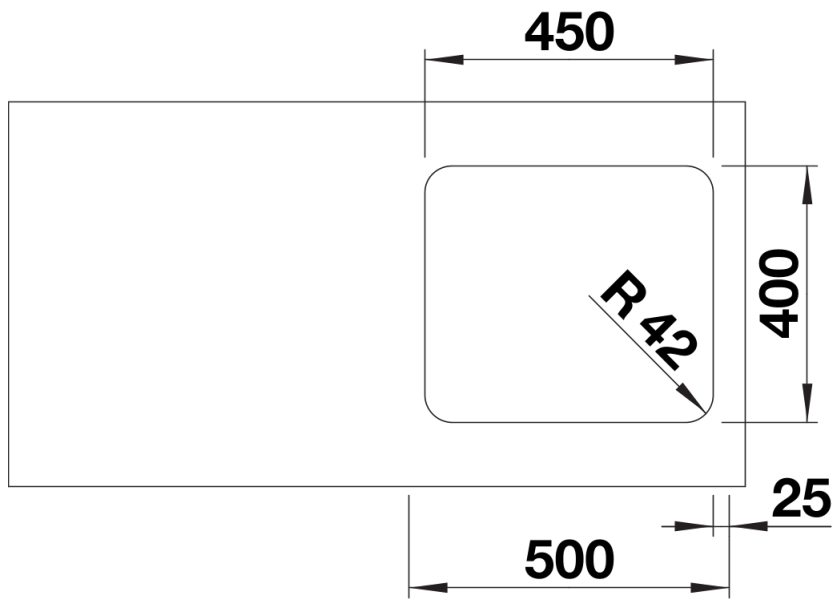

Cut-out

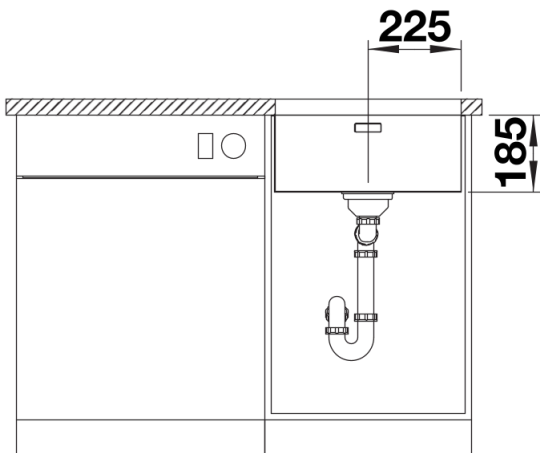

Front view

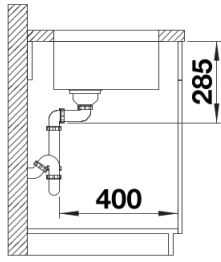

Side view