

Product information sheet SELECT II 60/3

Item no. 526204

Benefits



- Complete use of space in the sink cabinet thanks to dimensionally matched solutions, in harmony with the sink and mixer tap
- Wide range of models for all the most common cabinet dimensions
- Diverse and varied waste separation options through flexible bin combinations
- Simple installation without measuring, marking or pre-drilling
- Optional accessories enhance the system to create a custom solution
- Modern design with high-quality aluminium
- All parts are easy to clean thanks to the generous and smooth surfaces

Planning information

- Installation height 361 mm, installation depth 400 mm, necessary inside cabinet dimensions for pull-out rails 450 mm, cabinet side wall thickness 16 mm or 19 mm.
- For cabinets with 18 mm side wall thickness distance plates 243 513 must be ordered separately.
- This requires front doors without hinges or drill holes. Please note the handle position.
- Also suitable for installation in base cabinets with frame and panel doors with frames from 40 mm.
- When planning, please note the installation height of the waste management system, the installation depth of the sink and the resulting minimum dimensions of the base cabinet.
- Minimum recommended plinth height for MOVEX installation: 100 mm.

Scope of supply

- pull-out system for front attachment
- system cover
- 3 x 15 l bin

Details

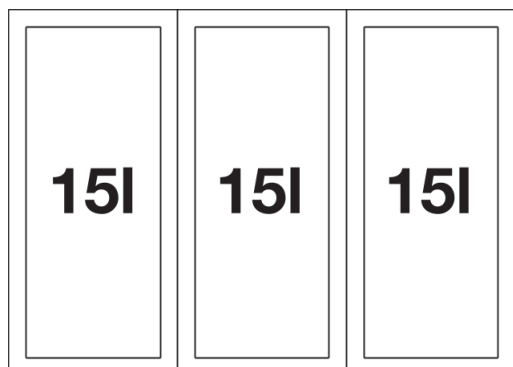

Top view

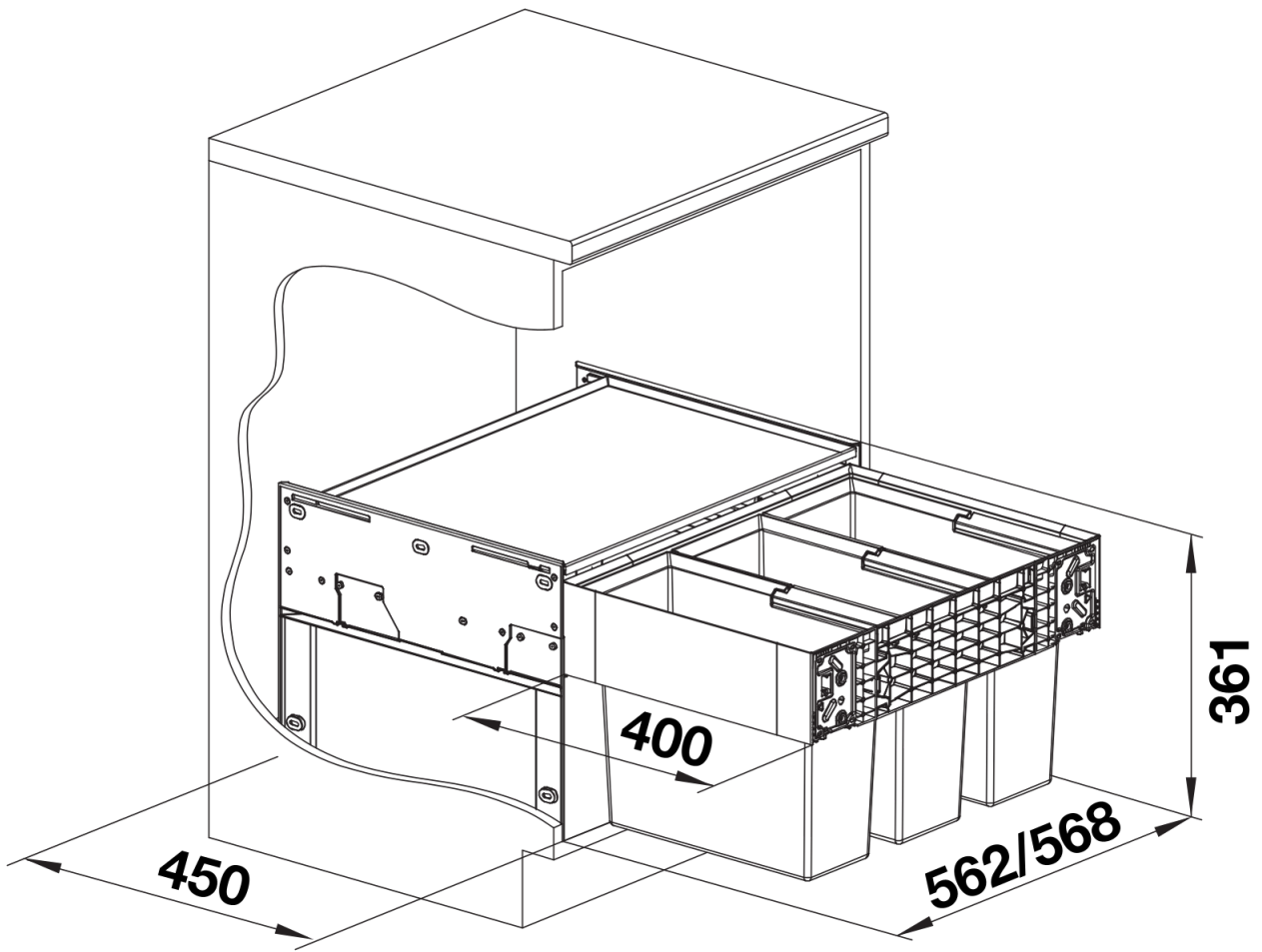

PRODUKT_3D