

Product information sheet FLEXON II Low 50/2

Item no. 526639

Benefits



- For base cabinets with divided drawers and a width of 50 to 90cm (thanks to a reduced installation height of 330 mm)
- Diverse waste separation and storage options through flexible bin combinations, with reduced space requirements in the sink cabinet
- High stability and clean through frame solution with hanging bins
- Simple installation without marking or pre-drilling
- Modern design with high-quality aluminium
- All parts are easy to clean thanks to the generous and smooth surfaces
- Optional accessories enhance the system to create an individual solution

Planning information

- A base cabinet with cover and pull-out is required.
- Installation height 325 mm above the drawer base, installation depth 400 mm.
- 450 mm drawer with full extension slides required.
- Maximum frame height 250 mm above the drawer base.
- Also suitable for installation in base cabinets with frame and panel doors with frames from 90 mm.
- When planning, please note the installation height of the waste management system, the height of the drawer base, the installation depth of the sink with the waste kit and the resulting minimum dimensions of the base cabinet.
- Minimum recommended plinth height for MOVEX installation: 100 mm.

Scope of supply

- system for installation in drawers
- 2 x 19 l bin

Details

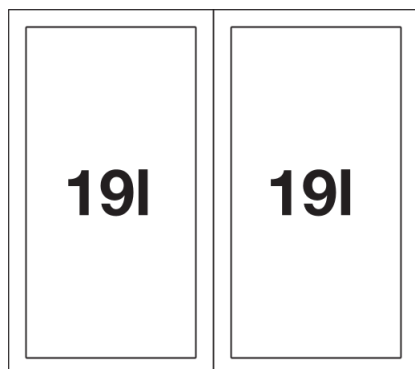

Top view

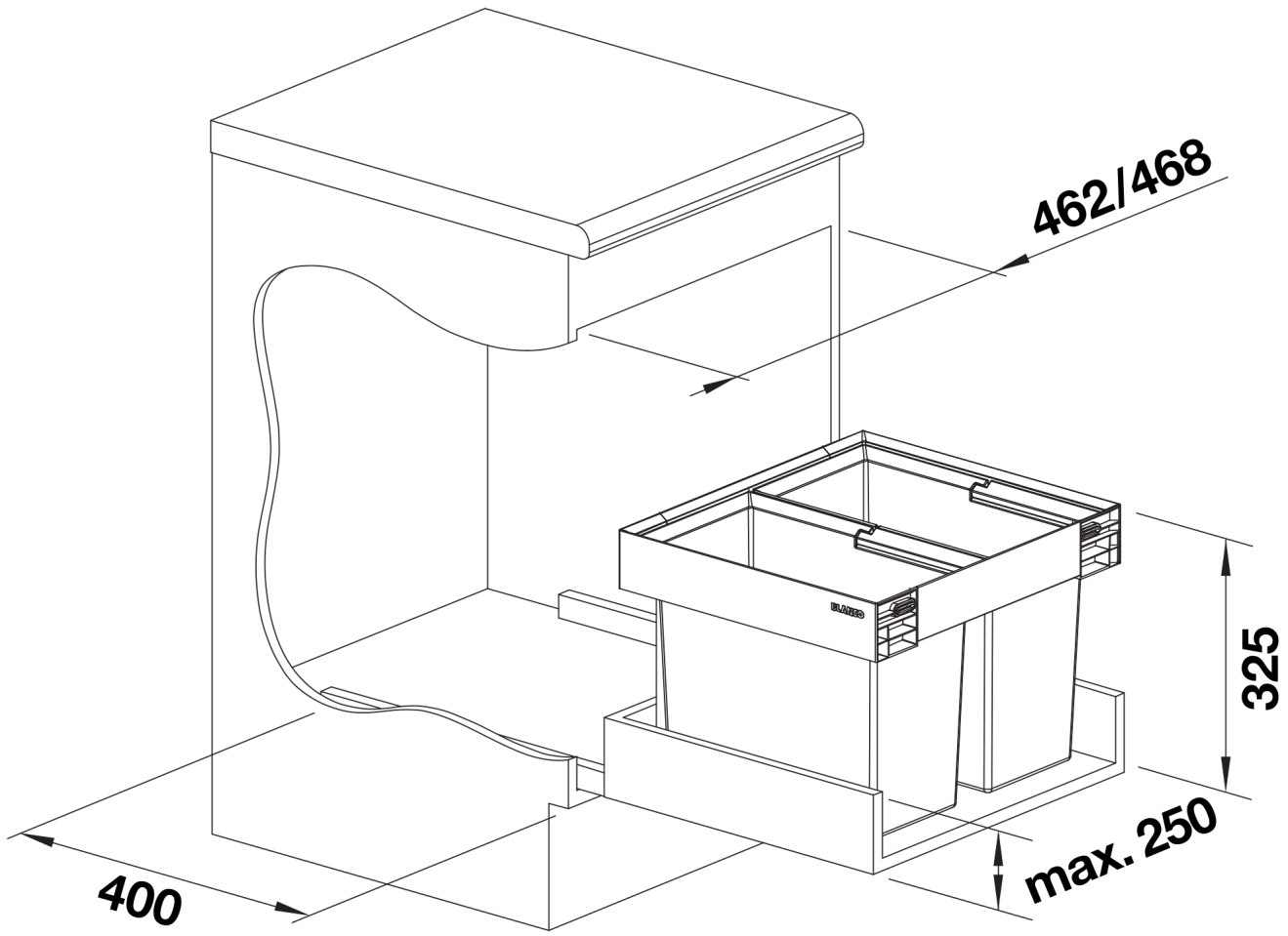

PRODUKT_3D