

## Product information sheet ANDANO 400/400-IF

Item no. 522985

### Benefits

---



- Unique composition of optical and functional elements
- The harmonious interplay between the radii and surface design creates a modern appeal
- High quality features consisting of a covered Coverflow and InFino drain system gracefully integrated and easycare
- Large bowl capacity and fully utilisable base
- Elegant IF flatrim for flushmount and for installation from above
- Optional premium accessories are available

## Planning information

---

- Flexible sealing tape is required when installing a kitchen mixer tap drain remote control or soap dispenser in laminate worktops item no 120 055
- Please note the cutout information for the respective installation method

## Scope of supply

---

- waste kit with spacesaving pipe
- 2 x 3 12 InFino basket strainer
- fixing kit

## Details

---

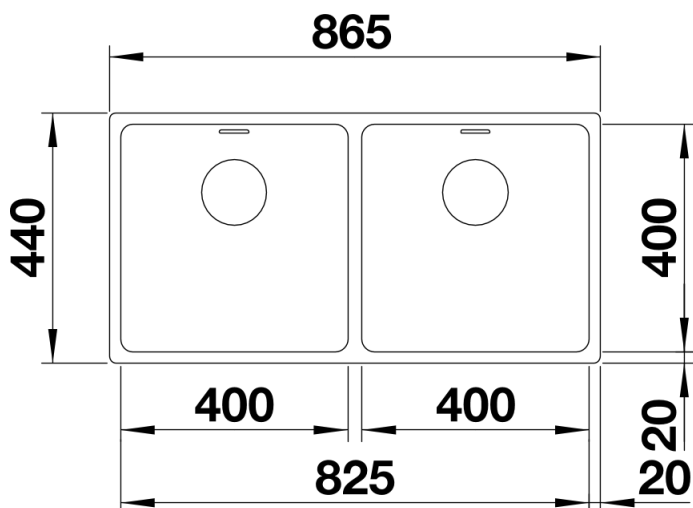

Top view

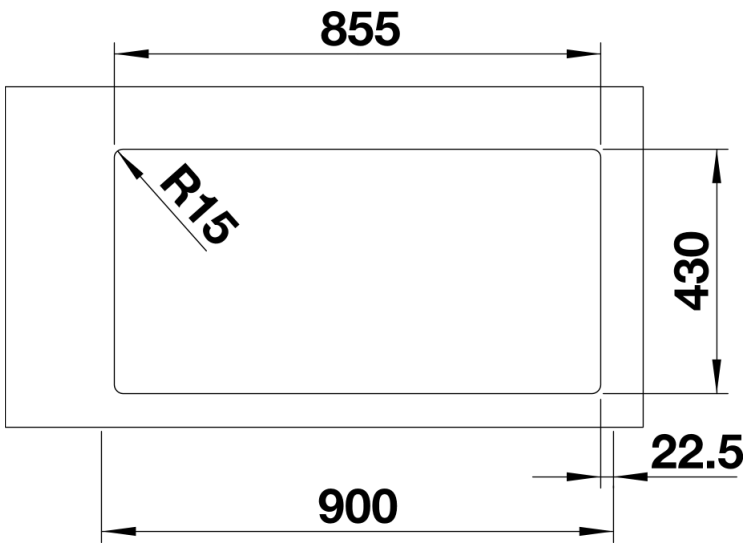

Cut-out

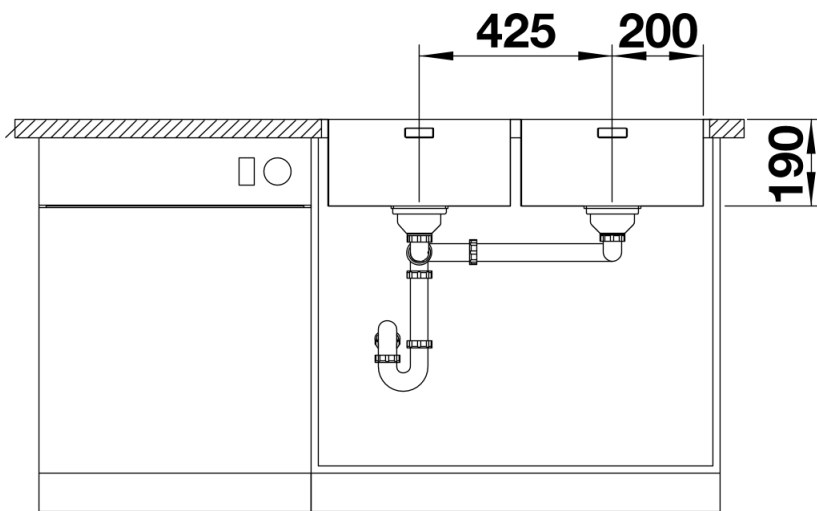

Front view

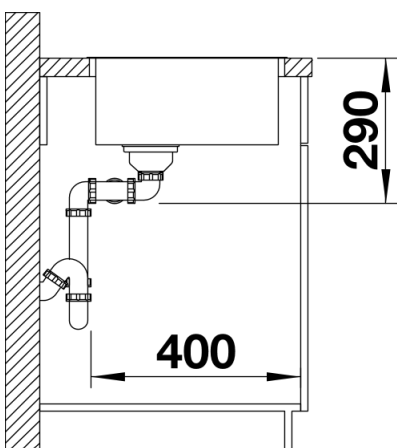

Side view