

Product information sheet BOTTON Pro 45/2 Manual

Item no. 517467

Benefits



- Compact system for positioning flexibly in the base cabinet
- Different models for the most common cabinet dimensions
- Easy to mount on the floor thanks to installation aid
- Functional design made of high-quality plastic
- Easy to clean bins with ergonomic handle
- Large waste volume despite compact dimensions

Planning information

- Installation instructions for the BLANCO BOTTON Pro Manual:
- Take account of the dimensions of the door hinges when calculating the installation width
- Installation depth 400 mm
- Installation height 350 mm

Scope of supply

- system for floor-mounting behind hinged doors
- 2 x 13 l bin

Details



Top view

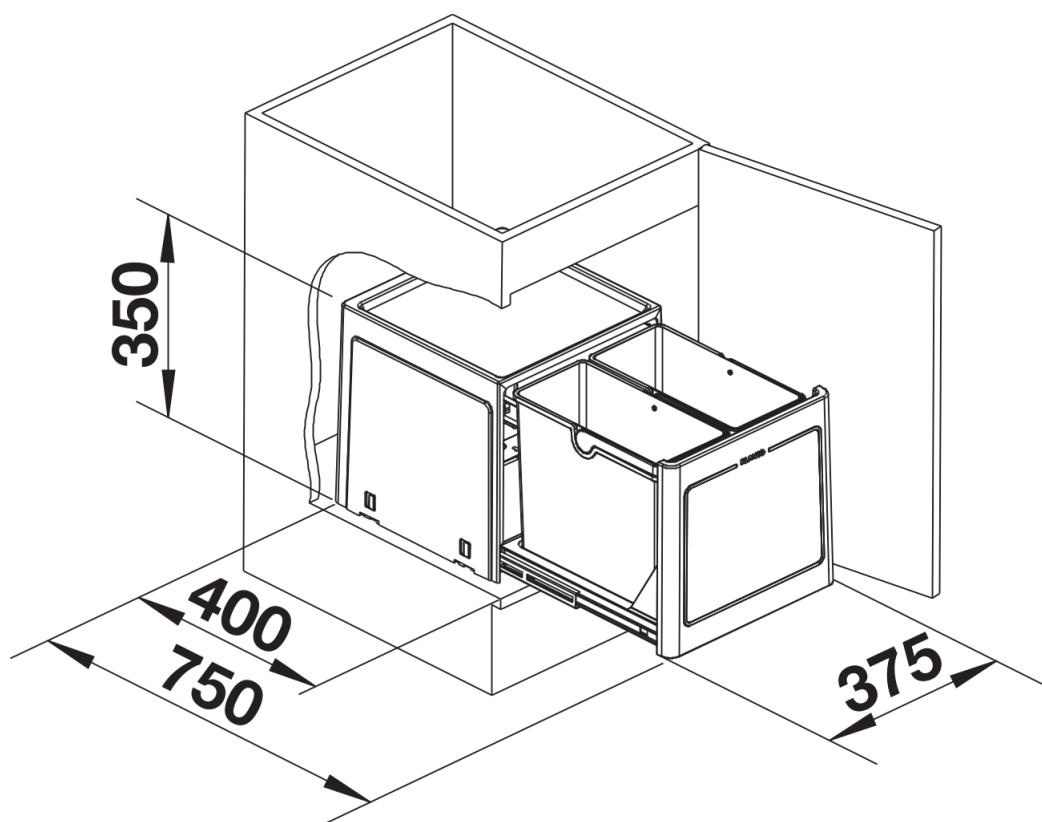

PRODUKT_3D