

Product information sheet CLARON 450-IF

Item no. 521574

Benefits



- Elegant-pure bowl design
- Concise 10 mm radius for a more refined design, without doing away with practical benefits
- Flush IF - flat rim
- Optimum utilisation of the bowl capacity thanks to extra-deep bowls and distinctively small radii
- InFino drain system – elegantly integrated and easy-care

Planning information

- Installing a kitchen mixer tap, drain remote control or soap dispenser in laminate worktops requires a flexible sealing tape
Please order drain connections for combinations of two individual bowls separately

Scope of supply

- waste kit with space saving pipe
- 3 ½" InFino basket strainer
- fixing kit

Details

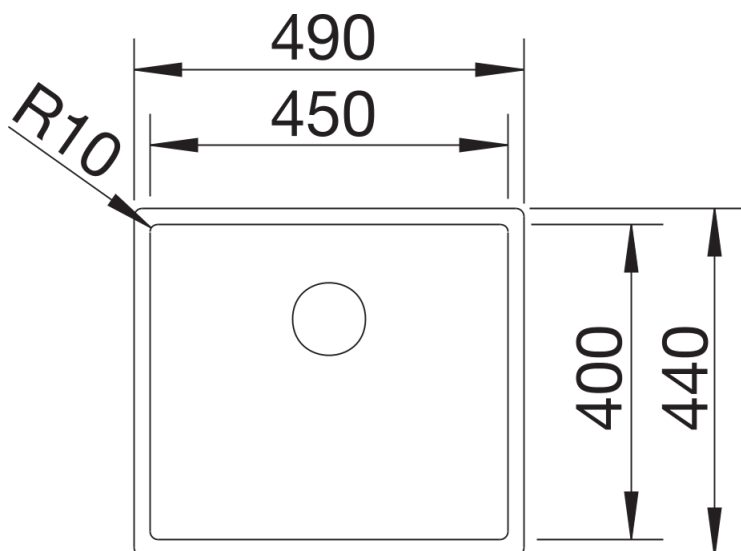

Top view

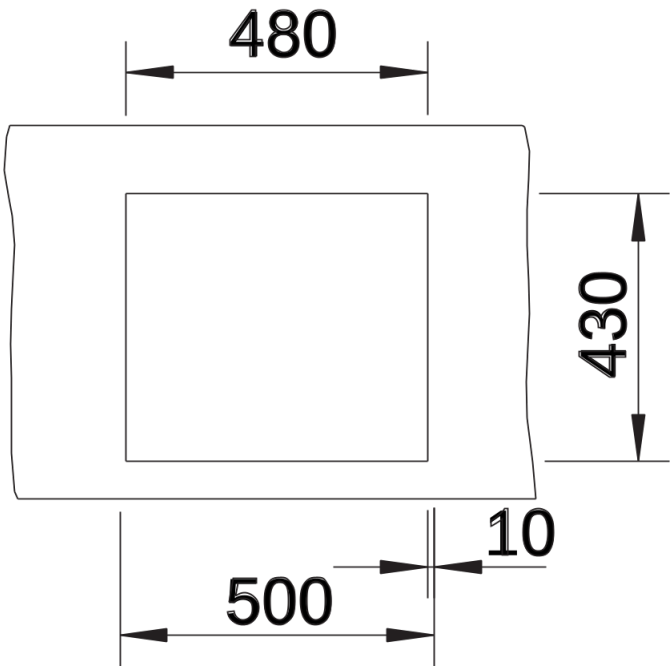

Cut-out