

Product information sheet ZEROX 500-IF

Item no. 521588

Benefits



- Zero-radius design with striking, right-angled bowl geometry
- Wide product range enables a plethora of bespoke combinations
- Flush IF - flat rim
- InFino drain system – elegantly integrated and easy-care
- Easy to combine, optimal accessory solutions

Planning information

- Note: also available as an undermount version.
- * Scope of supply note:
- a retrofit set is required for IF models without a tap ledge if using a drain remote control with pop-up.
- Recommended: item no. 232 459
- Installing a kitchen mixer tap, drain remote control or soap dispenser in laminate worktops requires a flexible sealing tape, item no. 120 055.

Scope of supply

- waste kit* with space saving pipe, 3 1/2" InFino basket strainer, fixing kit

Details

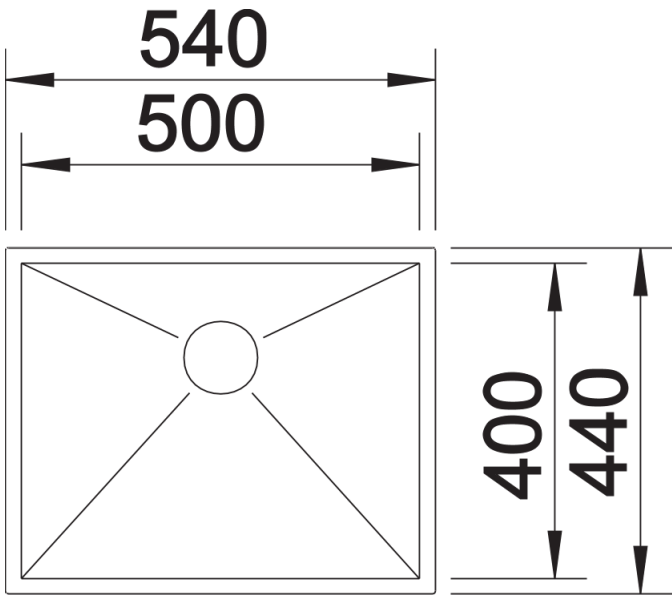

Top view