

Product information sheet SUBLINE 320-F

Item no. 523416

Benefits



- Bowls for modern kitchen designs
- Timelessly elegant, contoured bowl design
- High-quality features with covered C-overflow and InFino drain system – elegantly integrated and easy-care
- Optional versatile accessories are available

Colours



Available colours:

black
anthracite
rock grey
volcano grey
white
soft white
coffee

SILGRANIT anthracite

Planning information

- For worktop thicknesses of 15 mm and over, a space for the overflow must be cut out on the underside.
Model-related detailed dimensions and drawings can be found with the cut-out information online at www.blanco.com.

Scope of supply

- waste kit with space-saving pipe
- 3 ½" InFino basket strainer

Details

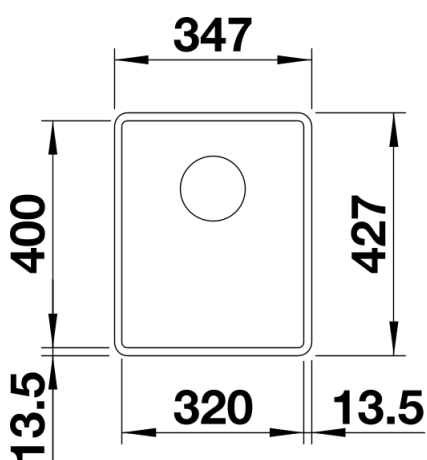

Top view

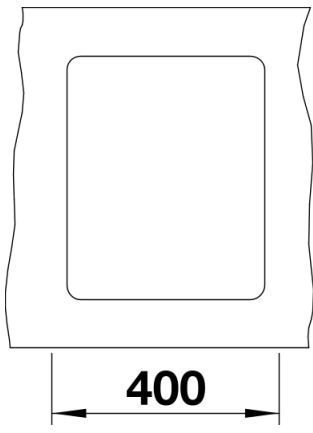

Cut-out

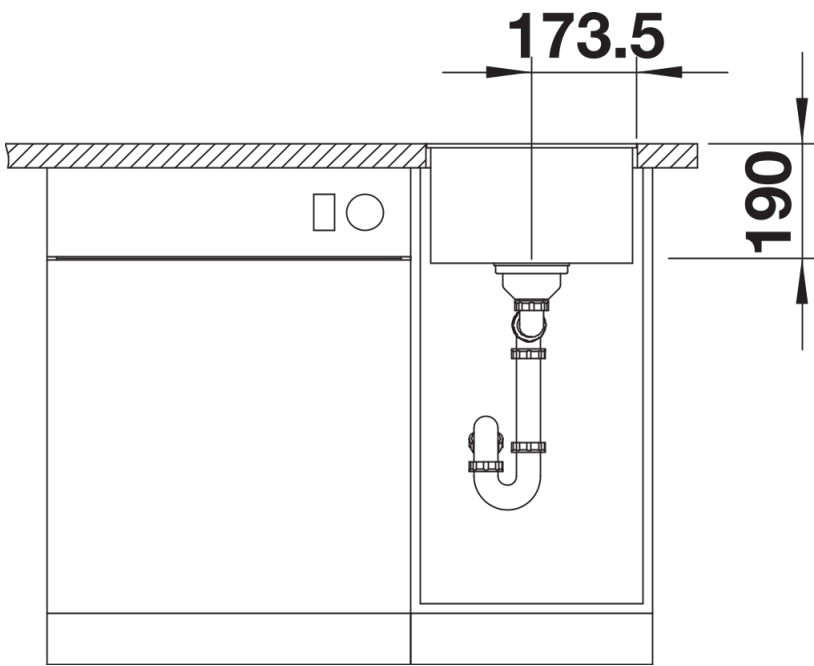

Front view

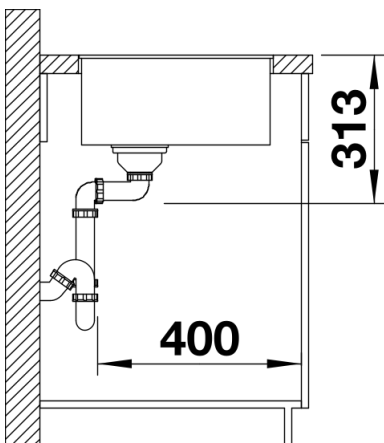

Side view